

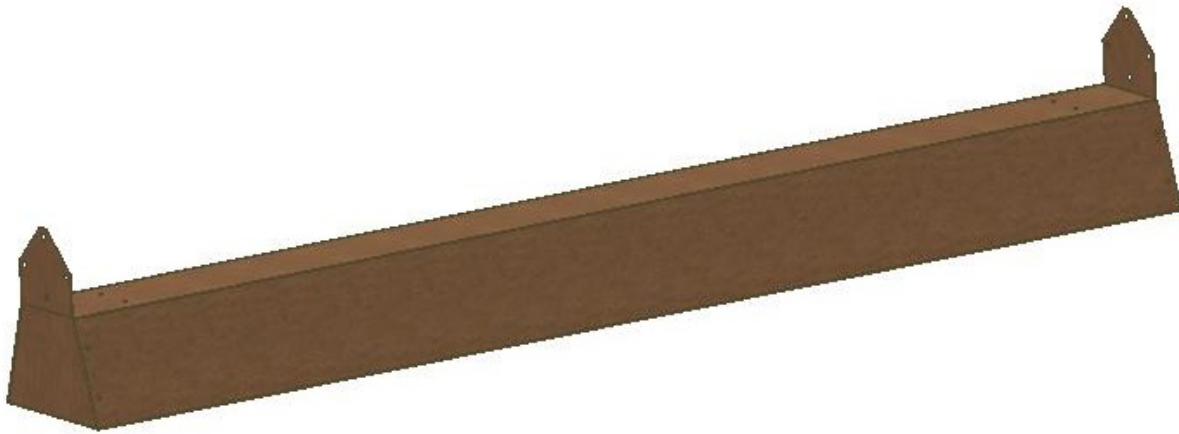

OCH-series

Cord Connected Units

Indoor * and Outdoor Comfort Heaters



* EXCLUDING RESIDENCES

	⚠ WARNING
	<p>IMPORTANT SAFETY INFORMATION INSIDE</p> <ul style="list-style-type: none">• Serious injury or death possible• Read, understand, and follow all safety information and instructions in this manual before using or servicing this product.• Retain these instructions for future reference.

REFER TO COMPLETE
INDEX OF INFORMATION
ON
PAGE 2



INDEX

Index	Page 2
Safety Signal Word Definitions	Page 2
Important Instructions	Page 3
Specifications	Page 4
Quartz Tube Installation	Page 5
Heater Installation	Pages 5 & 6
Wiring	Page 6
Maintenance	Page 7
Troubleshooting	Page 8



ATTENTION:

The table to the right provides definitions of the signal words that can be found throughout this manual. These signal words are used to express the severity of the hazard at hand. The signal words are generally used in conjunction with safety symbols that correspond to the text for that particular hazard. As you read this manual, refer back to this table when you are unsure of the signal word definition.

SIGNAL WORD DEFINITIONS	
 DANGER	DANGER indicates an imminently hazardous situation which, if not avoided, will result in death or serious injury.
 WARNING	WARNING indicates a potentially hazardous situation which, if not avoided, could result in death or serious injury.
 CAUTION	CAUTION indicates a potentially hazardous situation which, if not avoided, may result in minor or moderate injury.
CAUTION	CAUTION used without the safety alert symbol indicates a potentially hazardous situation which, if not avoided, may result in property damage.
As defined in ANSI Z535.4-2002	

IMPORTANT INSTRUCTIONS

When using electrical appliances, basic precautions should always be followed to reduce the risk of fire, electrical shock and injury to persons, including the following:

1. Read all instructions before using this heater.
2. **CAUTION:** High temperatures. Keep cords and all other combustible material, such as furniture, papers clothes and curtains away from the heater. For safe and efficient operation, heaters must be mounted a minimum of 12" from a vertical surface, a minimum of 3" from the ceiling, a minimum of 72" from direct radiation to combustibles, and a minimum of 6' above the floor. Heaters must be at least 36" apart.

ATTENTION: HAUT TEMPÉRATURES. Pour un fonctionnement sûr et efficace. CHAUFFE doit être monté un Minimum de 31cm d'une surface verticale, un minimum de 7.62cm du plafond, un minimum de 182cm DEADIATION DIRECTE DE COMBUSTIBLES ET UN MINIMUM DE 1.83m FROM LE SOL. NE PAS UTILISER CETTE BOITE DE CABLAGE. UTILISER 75°C FIL MINIMUM. DÉBRANCHER before ENTRETIEN.

3. Extreme caution is necessary when any heater is used by or near children or invalids and whenever the heater is left operating and unattended.
4. Do not operate any heater after it malfunctions, has been dropped or damaged in any manner. Return heater to authorized service facility for examination, electrical or mechanical adjustment, or repair.
5. Do not use outdoors unless specifically designated as an outdoor heater.
6. To disconnect heater, turn controls to off, and turn off power to heater circuit at main disconnect panel (or operate internal disconnect switch if provided).
7. Do not insert or allow foreign objects to enter any ventilation or exhaust opening as this may cause an electric chock or fire, or damage the heater.
8. To prevent a possible fire, do not block air intakes or exhaust in any manner.
9. A heater has hot and arcing or sparking parts inside. WARNING: Do not use it in area where gasoline, paint, or flammable liquids are used or stored.
10. Use this heater only as described in this manual. Any other use not recommended by the manufacturer may cause fire, electric shock, or injury to persons.
11. This heater may include an audible or visual alarm to warn that parts of the heater are getting excessively, hot If the alarm sounds (or illuminates), immediately turn the heater off and inspect for any objects on or adjacent to the heater that may have blocked the airflow or otherwise caused high temperatures to have occurred. **DO NOT OPERATE THE HEATER WITH THE ALARM SOUNDING (OR ILLUMINATING).**

12. SAVE THESE INSTRUCTIONS

SPECIFICATIONS

DESCRIPTION

Fostoria multi-purpose OCH series electric infrared heaters are designed to provide efficient spot heating for many commercial and industrial applications. All models operate with a single quartz tube emitter included with the heater, are easily installed, and are equipped with spectral reflectors for excellent radiant output. They are built with corrosion-resistant materials and are **listed** for both **INDOOR (excluding residences) AND OUTDOOR applications in the USA and Canada.**



WARNING

EXPLOSION HAZARD FIRE HAZARD

- Serious injury or death may occur.
- Do not use in locations containing hazardous atmospheres.
- Do not use inside residences.

SPECIFICATIONS

Housing	24 Ga. Galvanneal
Finish	Hi-temp brown powder coat
Reflector End caps	0.040" gold anodized aluminum
Suspension	Adjustable Mounting Bracket or Chain

Voltage	Cordset Plugs	Matching Receptacle
120V	NEMA 5-15P	NEMA 5-15R
240V	NEMA 6-15P	NEMA 6-15R

Model	P/N	Tube P/N	Watts	Volts	Amps	Cordset	Dim A*	Dim B	Dim C
OCH-46-120V-CE	04859702	04432302	1500	120	12.5	YES	48.0"	5.375"	6.500"
OCH-57-208V-CE	04859802	04416602	3000	208	14.4	**	59.0"	5.375"	6.500"
OCH-57-240V-CE	04859902	04414702	3000	240	12.5	YES	59.0"	5.375"	6.500"

**208 Volt Models are supplied with a 6 ft cord only (no plug)

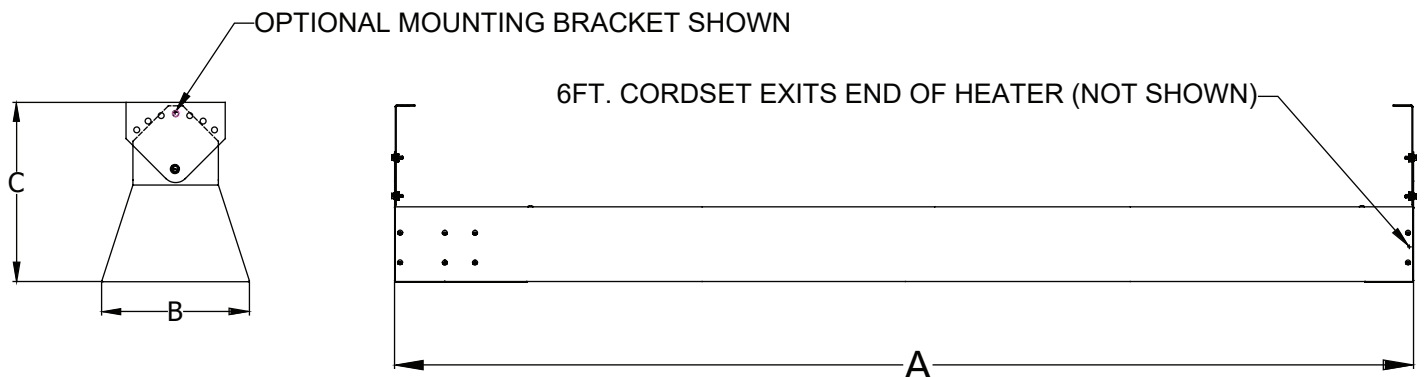

QUARTZ TUBE INSTALLATION

⚠ WARNING

ELECTRIC SHOCK HAZARD



- Serious injury or death may occur.
- Disconnect from electrical supply before installing or servicing this heater.
- Reflector end caps must be installed prior to powering the unit; refer to note 3.

Each heater is equipped with two hi-temperature silicone lead wires and a ground termination. **Make sure power source conforms to the heater requirements. Use only Fostoria quartz tubes.**

1. Insert quartz tube in the “L”-shaped slots in heater housing.
2. On each end of the quartz tube, place (1) lead wire ring terminal, (1) lock washer and (1) hex nut on the threaded stud and **tighten securely** (see image below). Lock washers and hex nuts are provided in hardware package.

NOTE – Use a second wrench to hold the inner hex nut in place while tightening the outer hex nut. Failure to securely tighten this connection will cause the element to fail prematurely.

CAUTION

Install heater so that the quartz tubes are horizontal. Failure to do this may cause the heating element within the tube to sag and cause premature burnout.

QUARTZ TUBE

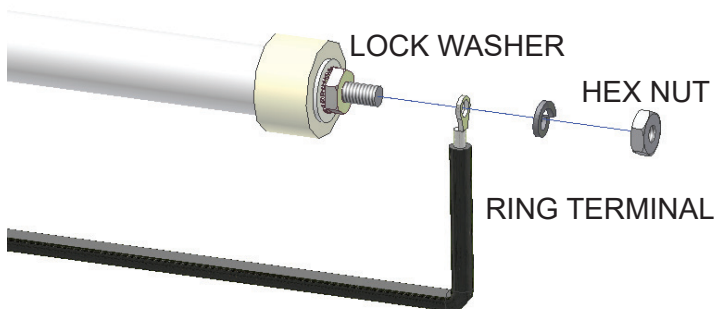

3. Attach reflector end caps to both ends of housing using the (4) screws provided in hardware package.

HEATER INSTALLATION

MINIMUM INSTALLATION CLEARANCES

These heaters **MUST** be installed as follows:

- 12 inches minimum from a vertical surface
- 72 inches minimum from ANY combustible material
- 3 inches minimum from the ceiling
- 36 inches minimum from other heaters

⚠ WARNING

FIRE HAZARD



- Serious injury or death may occur.
- Read and follow clearances shown in box at left for ALL OCH series heater installations.
- Do not use inside residences.

NOTE: For optimum spot heating performance, it is recommended that the distance from the floor should be approximately 7 to 9 feet for the OCH-46 model, and 8 to 10 feet for OCH-57 models.

SUSPENSION ALTERNATIVES

Your OCH series heater can be mounted with either the adjustable mounting brackets or by chain suspension. Both mounting options are included with the heater in the hardware package.

Standard Mounting:



In the hardware bag shipped with your heater you will find two adjustable mounting brackets and fastening hardware. Using the mounting centers specified in figures 1 & 2, mount your adjustable mounting brackets (bends to the inside). Once mounted, assemble the heater to brackets (figure 3) with mounting hardware, these brackets enable the heater to be angled in 15-degree increments up to 45 degrees.

Chain Suspension:

The heater can also be chain-hung as shown in figure 4. Cut the 16ga. chains (two 4 foot chains are provided) to desired length. Attach chains to heater with "S"-hooks provided and suspend from overhead structure. Crimp "S"-hooks closed after assembly.

CAUTION

Install heater so that the quartz tubes are horizontal. Failure to do this may cause the heating element within the tube to sag and cause premature burnout

  	⚠ WARNING
	ELECTRIC SHOCK HAZARD
	<ul style="list-style-type: none"> Serious injury or death may occur. Disconnect from electrical supply before installing or servicing this heater. Read and follow installation clearance requirements on page 4.

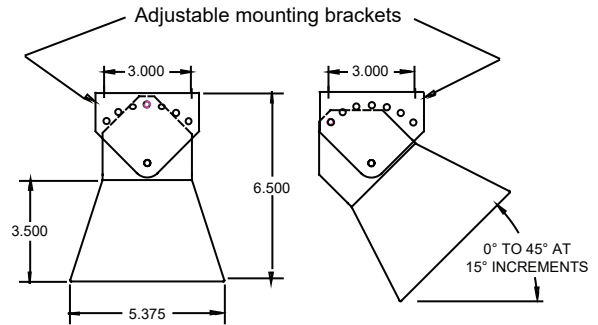

Figure 1: End View

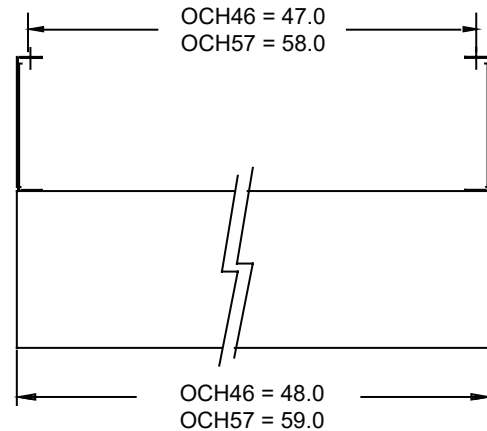

Figure 2: Side View

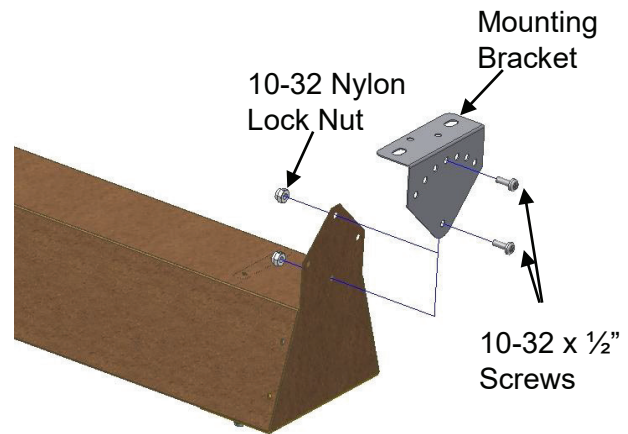

Figure 3: Mounting View

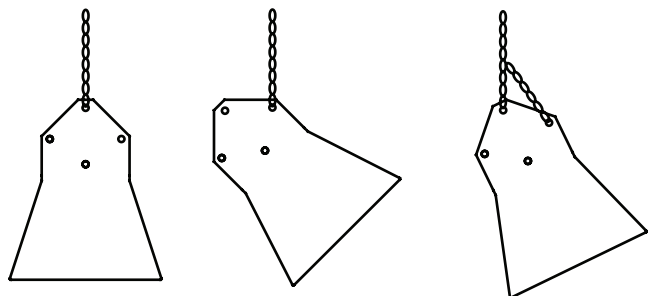
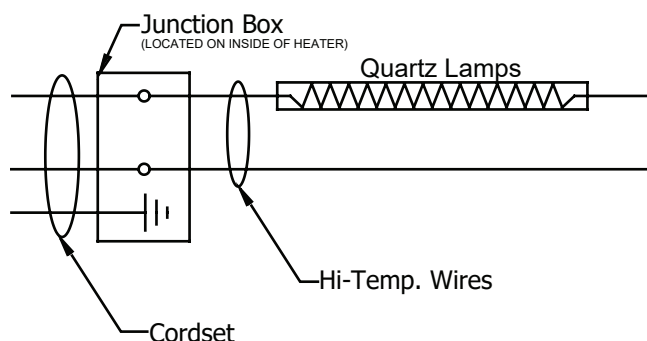

Figure 4: Mounting View

WIRING

INTERNAL WIRING DIAGRAM

OCH heaters are equipped with two hi-temperature silicone lead wires and a bonding* (ground) termination.



*Bonding is the term that describes the completion of the electrical circuit back to its source, which allows a breaker or fuse to clear if a short occurs in the line.

All field connections must be protected from exposure to water.



WARNING

ELECTRIC SHOCK HAZARD

- Serious injury or death may occur.
 - Disconnect from electrical supply before installing or servicing this heater.
 - Read and follow all safety information in box below.
-
- Make certain the power source conforms to specifications on the heater label.
 - Do not depend on a thermostat or other switch as the sole means of disconnecting power when installing or servicing heater. Always unplug the cordset or open the safety switch and lock it open.
 - All wiring must be performed by a licensed electrician.
 - The cordsets supplied with these heaters are equipped with provisions for proper bonding (grounding). Always mate the cordset plug with the proper bonded (grounded) receptacle in accordance with the National Electric Code and all governing local codes and ordinances.
 - Do not use an extension cord to provide power to these heaters.
 - Never connect the green or green-yellow wire to a live or "hot" conductor.

MAINTENANCE

1. **Always disconnect heater from power supply before performing any maintenance or service.**
2. Periodically clean the reflector with a dampened soft cloth using mild detergent. Rinse with water and wipe dry with a clean soft cloth.



⚠ **WARNING**

ELECTRIC SHOCK HAZARD

- Serious injury or death may occur.
- Disconnect from electrical supply before installing or servicing this heater.
- Reflector end caps must be installed prior to powering the unit; refer to note 3.

TROUBLESHOOTING

SYMPTOM	POSSIBLE CAUSE(S)	CORRECTIVE ACTION
Element does not energize.	<ol style="list-style-type: none"> 1. Defective element. 2. Improper connection. 	<ol style="list-style-type: none"> 1. Replace element. 2. Check connection to power outlet.
Not enough heat.	<ol style="list-style-type: none"> 1. Heater too small for application. 2. Heater mounted too high or too far. 	<ol style="list-style-type: none"> 1. Add additional heater(s) 2. Decrease mounting height or distance.
Too much heat.	<ol style="list-style-type: none"> 1. Heater too large for application. 2. Heater mounted too low or too close. 	<ol style="list-style-type: none"> 1. Replace with smaller heater. 2. Increase mounting height or distance.
Hot spot in tube.	<ol style="list-style-type: none"> 1. Heater is not level. 2. Grease or moisture on tube. 	<ol style="list-style-type: none"> 1. Adjust to a level mount. 2. Clean tube-replace if problem persists.