

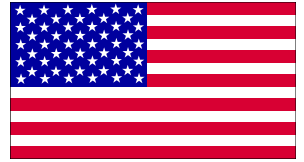

TPI Corporation  
P.O. BOX 4973  
JOHNSON CITY, TN 37602  
www.tpicorp.com



# FSP-Series

## Heavy-Duty Flat Panel Emitter Electric Portable Infrared Heaters



### **WARNING**

#### IMPORTANT SAFETY INFORMATION INSIDE

- Serious injury or death possible
- Read, understand, and follow all safety information and instructions in this manual before using or servicing this product.
- Retain these instructions for future reference.

REFER TO COMPLETE  
INDEX OF  
INFORMATION ON  
PAGE 2



# INDEX

General Description & Use	Page 3
Specifications	Page 4, 5
Installation Planning	Page 5, 6, 7
Installation - Wiring	Page 7, 8, 9
Operation	Page 10
Maintenance	Page 11
Accessories	Page 11



### ATTENTION:

The table to the right provides definitions of the signal words that can be found throughout this manual. These signal words are used to express the severity of the hazard at hand. The signal words are generally used in conjunction with safety symbols that correspond to the text for that particular hazard. As you read this manual, refer back to this table when you are unsure of the signal word definition.

SIGNAL WORD DEFINITIONS	
	DANGER indicates an imminently hazardous situation which, if not avoided, will result in death or serious injury.
	WARNING indicates a potentially hazardous situation which, if not avoided, <b>could</b> result in death or serious injury.
	CAUTION indicates a potentially hazardous situation which, if not avoided, <b>may</b> result in minor or moderate injury.
	CAUTION used without the safety alert symbol indicates a potentially hazardous situation which, if not avoided, <b>may</b> result in property damage.
As defined in ANSI Z535.4-2002	

## THANK YOU!!

Thank you very much for selecting Fostoria's portable electric infrared heating equipment for your comfort heating needs. These products were engineered with the most reliable components and materials available and are equipped with features to assure ease of installation and maintenance.

The warmth you will now enjoy when using this heating equipment is created by a heat source; a flat panel emitter; that emits infrared energy in the form of heat, like the sun. This is an economical way to heat because it heats people and objects, not the air, so you don't need to heat a large area to feel warm.

### CHECKING YOUR SHIPMENT

- Upon receipt of your shipment, check all cartons for visible damage.
- Claims for damaged material or shortages that were not evident upon receipt of shipment must be reported to carrier and TPI Corporation's customer service (800-251-0382) immediately.
- Any accessory items ordered for the heater will be shipped in separate cartons.

## GENERAL DESCRIPTION & USE

 <b>WARNING</b>	
	EXPLOSION HAZARD
	FIRE HAZARD
	BURN HAZARD
	
	<ul style="list-style-type: none"><li>• Serious injury or death may occur.</li><li>• Not for indoor residential use.</li><li>• Do not use outdoors in wet conditions and in unprotected locations.</li><li>• Use for comfort heating only.</li><li>• Do not use in locations containing hazardous or explosive atmospheres.</li></ul>

The Fostoria FSP-series is a line of heavy-duty portable heaters designed to provide electric infrared heat when permanently installed heaters are not practical or economical. They are easily transported to the work site and connected to disconnect switches or lighting centers. The units are suited to a wide variety of indoor and protected outdoor commercial or industrial uses. They operate cleanly, emitting no fumes or odors.

Applications where combustible materials and/or personnel will be located near these heaters require the addition of a ground-fault sensing switch as part of the electrical circuit. See the INSTALLATION PLANNING section of this manual for more details. Any installation of these heaters must also adhere to the minimum clearance information below.

MODEL	REQUIRED CLEARANCES TO COMBUSTIBLES FROM FRONT OF HEATER
FSP-1412-1C	3 FEET
FSP-31	3 FEET
FSP-43	4 FEET
FSP-95	7 FEET

## SPECIFICATIONS

### FSP-14 & FSP-31 Series:

- Aluminized steel base and large carry handle.
- Gold-anodized aluminum housing for good reflectivity and corrosion resistance
- 120V model (FSP-1412-1C) is equipped with 15ft cordset with NEMA 5-15 molded plug.
- Heavy-duty wire guard for element and personnel protection.

### FSP-43 & FSP-95 Series:

- Heaters are mounted on steel handcarts with 6-inch wheels, which allow easy transport to the job site.
- Gold-anodized aluminum housing for good reflectivity and corrosion resistance.
- Heavy-duty wire guard for element and personnel protection.

TABLE A

MODEL	VOLTS	WATTS	AMPS		Btu's/Hr	Dimensions (INCHES)			WEIGHT (lbs)
			1PH	3PH		A	B	C	
FSP-1412-1C	120	1450	12.1	N/A	4947	14-1/2	11-1/2	25	17
FSP-3120-1	208	3150	15.4	N/A	10,749	14-1/2	11-1/2	46-1/4	23
FSP-3124-1	240	3150	13.13	N/A					
FSP-3127-1	277	3150	11.37	N/A					
FSP-3148-1	480	3150	6.56	N/A					
FSP-3157-1	600	3150	6.48	N/A					
FSP-4320-3	208	4300	20.67	11.94					
FSP-4324-3	240	4300	17.91	10.36					
FSP-4327-1	277	4300	15.52	N/A					
FSP-4348-3	480	4300	8.96	5.18					
FSP-4357-1	600	4300	7.48	7.48					
FSP-9520-3	208	9500	45.67	26.39	32,414	17-1/2	20	53	46
FSP-9524-3	240	9500	39.68	22.89					
FSP-9527-1	277	9500	34.3	N/A					
FSP-9548-3	480	9500	19.79	11.44					
FSP-9557-3	600	9500	16.52	9.54					

Please see illustrations on next page regarding dimensions in table.

## SPECIFICATIONS (con't.)

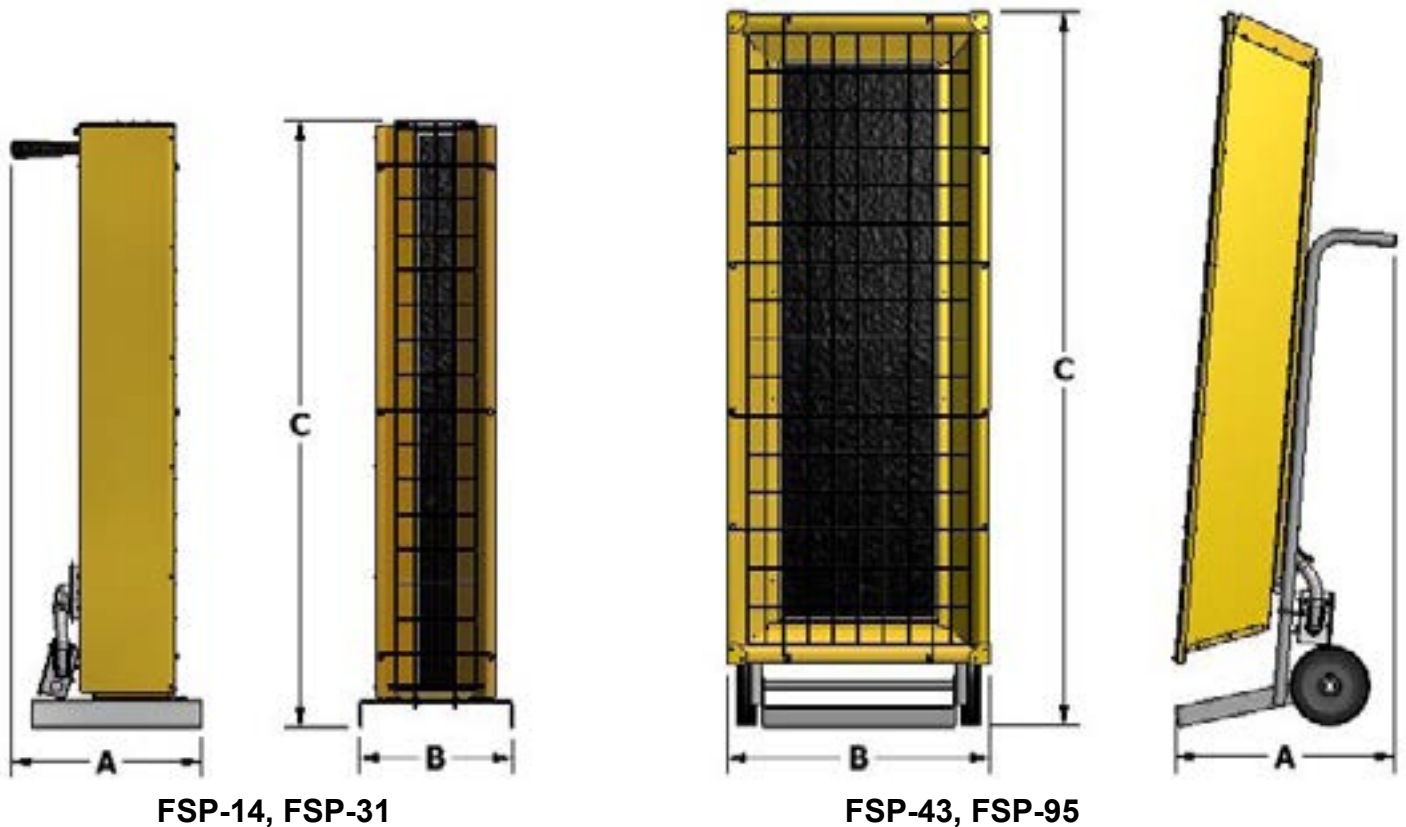

## INSTALLATION PLANNING

### Installer Qualifications

The installation and wiring of Fostoria FSP heaters must be performed by a licensed electrician.

### Installer Responsibility

The National Electric Code (NEC) and local codes and ordinances together with specifications provided by Fostoria comprise the information needed for proper installation. The installer must furnish all materials that have not been purchased from Fostoria or its representatives. It is the installers responsibility that the materials and methods of installation result in a job that is workmanlike and compliant with all applicable codes.

## INSTALLATION PLANNING (con't.)

**WARNING**

**FIRE HAZARD**

- Serious injury or death may occur.
- Heater circuit load calculations and circuit design must be done by a licensed electrician or engineer.

### Preparations for Wiring Heaters

- The maximum ampacity rating for an infrared heating circuit is 48.
- The opening in the terminal box for branch circuit supply wiring on FSP-14 and FSP-31 models is sized for 1/2-inch trade size cable connectors. Openings in terminal boxes for supply wiring on FSP- 43 and FSP-95 models are sized for 3/4-inch trade size cable connectors.
- Cable connectors and cables are not provided with these heaters.
- (See Specifications on page 7 for exceptions.)

The following tables are provided to assist the licensed electrician in sizing the electric cables and/or plugs needed for each FSP heater model. Since only model FSP-1412-1C is equipped with cables and plugs, these items for all other models will have to be obtained through a local supplier or purchased separately from Fostoria. (See Table B.). Please note certain models in bold in the chart below come with 15 feet of SO cable. All supply cables must be copper, rated 90°C and comply with all local codes and the National Electric Code (NEC).

All recommended wire sizes assume a 50ft. maximum wire length.

MODEL	VOLTS	WATTS	AMPS		TYPE SO CABLE SIZE		PLUG SIZE	
			1-PH	3-PH	1-PH	3-PH	1-PH	3-PH
FSP-3120-1	208	3150	15.14	N/A	14/3	N/A	20A/250V/3 WIRE	N/A
FSP-3124-1 <b>H31-FSP-1*</b>	240	3150	13.13	N/A	14/3	N/A	NEMA L6-16	N/A
FSP-3127-1	277	3150	11.37	N/A	16/3	N/A	NEMA L7-17	N/A
FSP-3148-1 <b>P31-FSP-1*</b>	480	3150	6.56	N/A	16/3	N/A	NEMA L8-20	N/A
FSP-3157-1	600	3150	5.48	N/A	16/3	N/A	NEMA L9-20	N/A
FSP-4320-3	208	4300	20.67	11.94	12/3	14/4	30A/250V/3 WIRE	20A/250V/4 WIRE
FSP-4324-3 <b>H43-FSP-3*</b>	240	4300	17.91	10.36	14/3	14/4	30A/250V/3 WIRE	20A/250V/4 WIRE
FSP-4327-1	277	4300	15.52	N/A	14/3	N/A	20A/480V/3 WIRE	N/A
FSP-4348-3 <b>P43-FSP-3*</b>	480	4300	8.96	5.18	16/3	14/4	20A/480V/3 WIRE	20A/480V/4 WIRE
FSP-4357-3	600	4300	7.48	7.48	16/3	14/4	20A/600V/3 WIRE	20A/600V/4 WIRE
FSP-9520-3	208	9500	45.67	26.39	6/3	8/4	60A/250V/3 WIRE	20A/600V/4 WIRE
FSP-9524-3 <b>H95-FSP-3*</b>	240	9500	39.58	22.89	8/3	10/4	50A/250V/3 WIRE	30A/250V/4 WIRE
FSP-9527-1	277	9500	34.3	N/A	8/3	N/A	50A/480V/3 WIRE	N/A
FSP-9548-3 <b>P95-FSP-3*</b>	480	9500	19.79	11.44	12/3	14/4	30A/480V/3 WIRE	20A/480V/4 WIRE
FSP-9557-3	600	9500	16.52	9.54	14/3	14/4	20A/600V/3 WIRE	20A/600V/4 WIRE

\* These models are provided from the factory with 15 feet of SO cable.

## INSTALLATION PLANNING (con't.)

Table B



ELECTRIC CABLES			
SIZE/TYPE	PART NUMBER	SIZE/TYPE	PART NO.
16/3 SO	08804300	8/3 SO	08805200
14/3 SO	08804600	8/4 SO	08805100
14/4 SO	08804900	6/4 SO	03164001
12/3 SO	08804500	4/3 SO	08805300
12/4 SO	03164201	2/3 SO	08804700
10/3 SO	08804400		

## INSTALLATION-WIRING

### For All Heaters

⚠ **WARNING**

ELECTRIC SHOCK  
HAZARD

- Serious injury or death may occur.
- Disconnect heater and lock out from electrical supply before installing or servicing.
- Always securely connect green wire on heater to bonding (green) wire from electrical supply.

The FSP-series heaters do not have any on board controls and therefore all permanently connected heaters must be used in conjunction with the applicable Fostoria FPC-series control center or be wired to a listed, properly rated safety switch for on/off control. Always disconnect the power at the circuit breaker or disconnect switch before installing electric power to the heater. If the breaker or disconnect switch cannot be seen from where you will be working, lock it in the open position and tag it to prevent unexpected application of power. Failure to do so could result in fatal electric shock. Do not depend on a thermostat or other switch as the sole means of turning off power to the heater.

To disconnect power to heaters using wall receptacles and plugs, simply unplug the heater.

“Bonding” is the intentional electrical connection of all non-current carrying metal parts to the equipment grounding (green) conductor of the heater and then terminating this green conductor to the green conductor of the power supply to form a low-impedance path back to the power supply so that safety devices (circuit breakers, fuses) can quickly remove dangerous touch voltage from these parts when a fault occurs. Always securely connect the green conductor from the power supply to the green conductor of the heater.

## INSTALLATION - WIRING

### Wiring of FSP- Series Heaters

Since all FSP- Series heaters (except FSP-1412-1C) are received without an electric cable installed, the following steps must be taken before attaching the heater to the base:

1. Install a standard or liquid-tight cable connector into the hole in the side of the terminal box. (See page 6 for appropriate cable connector sizes.) Note: If a connector larger than 3/4" is required, a hole must be pulled in the the junction box cover to accommodate the required fitting size. An extension ring may be used to provide additional wiring space.
2. Place the properly sized supply cable through the fitting. See page 6 for cable and plug size specifications or refer to the National Electric Code (NEC).
3. Connect supply cable leads to the element lead wires in the terminal box with wire nuts or other safe mechanical means. Black and white cable leads can be connected to either element lead wire. Connect green lead from supply cable to green (bonding) lead in the terminal box. See page 9 for wiring options.
4. Secure handle to rear of FSP-14 and FSP-31.( Not required on other models.)
5. Connect heater to appropriate electric circuit.



# WIRING SCHEMATIC FOR FSP-14, FSP-31 FSP-4327-1 AND FSP-9527-1 MODELS

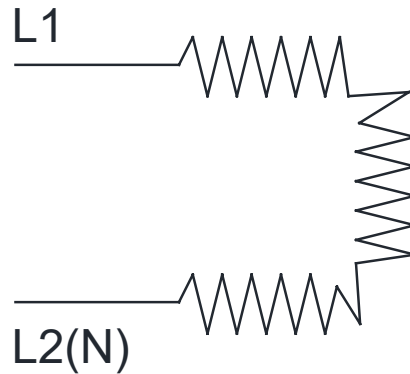

## FOR ALL OTHER MODELS

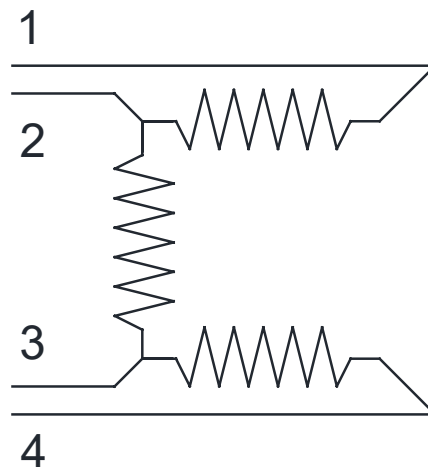



FOR 3PH OPERATION

L1-1 & 4, L2-2, L3-3.

FOR 1PH OPERATION

L1-1 & 3, L2(N)-2 & 4.

## OPERATION

	<b>⚠ WARNING</b>
	<p>EXPLOSION HAZARD</p> <p>FIRE HAZARD</p> <p>BURN HAZARD</p>
  	<ul style="list-style-type: none"> <li>• Serious injury or death may occur.</li> <li>• Always operate heaters on level surfaces.</li> <li>• Allow heater to fully cool after power is removed before touching or working on it.</li> <li>• Do not leave heaters unattended while in operation.</li> <li>• Maintain minimum clearances to combustibles as shown in table below.</li> </ul>

When power is provided to these heaters the heater elements will take several minutes to achieve full infrared output that can be confirmed by an orange to dull red glow on the element face. The element coil under this condition is operating between 1,500 and 1,600° F emitting medium wave length (approx. 3 microns or millionths of a meter) infrared energy. This energy, that can also be considered “radiation” is not harmful, yet is very effective at heating objects and surfaces that are within the line-of-sight of the elements and the heater’s reflective surfaces.

When power is provided or removed from these heaters, you may hear unfamiliar sounds that are caused by the expansion and contraction of metal components in the heater. This is normal.

There are no on/off switches, tip-over switches or over-temperature safety cut out devices included on any of these heaters. See the Accessories section of this manual for more details.

MODEL	REQUIRED CLEARANCES TO COMBUSTIBLES FROM FRONT OF HEATER
FSP-1412-1C	3 FEET
FSP-31	3 FEET
FSP-43	4 FEET
FSP-95	7 FEET

## MAINTENANCE

### Pre-Season Maintenance and Annual Inspection

To ensure your safety and years of trouble-free operation from the heaters, periodic service and inspections must be done by a trained maintenance person or licensed electrician.

To obtain maximum performance from your heater(s) each year, we recommend the following be performed at the start of the heating season:

1. Clean housing reflector surfaces with a damp cloth.
2. Blow or dust off the elements and inner reflectors.
3. Repair or replace damaged power cables.
4. DO NOT hose-down these heaters.

### Storage

When storing the heaters for long periods they should be covered to avoid accumulation of dust and other contaminants. Keep them in dry areas away from dripping or standing water and heavy humidity.



## ACCESSORIES



DC-SK-1  
Disconnect switch  
Part No.: 05893702

-Wall mountable for all FSP models  
-Mounts directly on FSP-43 & FSP-95  
models only