

american stabilis

INSTALLATION INSTRUCTIONS
ARCHITECTURAL DRAFT BARRIER
SERIES DBTS
SHOWN WITH OPTIONAL PEDESTALS

GENERAL:

American stabilis architectural draft barrier heaters may be mounted individually, end to end and wall to wall. Each heater is factory pre-wired, ready for branch circuit connection. Draft barrier heaters are constructed of 12 gauge aluminum and are equipped with an aluminum finned heating element, automatic reset thermal cut-outs and are available with optional relays, disconnect switch, and transformer relays. integral thermostat and disconnect switch are also available as accessories. Control section required.

RECEIVING:

Make sure that the number of cartons agree with the bill of lading, packing list and original order. Material was shipped in good order and american stabilis holds clear bill of lading, therefore any concealed damage must be reported at once to the carrier for inspection and settlement.

ROUGH-IN WIRING:

1. Run branch circuit of proper voltage and wire size to location of the terminal box of the heater. Table below provides correct wire size for wire entry.

TABLE 1

| | Rough-In Wire Size | MAXIMUM WATTS PER CIRCUIT USING 75°C WIRE | | | |
|---------------|--------------------|---|------|------|------|
| | | 120V | 208V | 240V | 277V |
| Copper Wire | 14 | 1440 | 2496 | 2880 | 3324 |
| | 12 | 1920 | 3328 | 3840 | 4432 |
| | 10 | 2880 | 4992 | 5760 | 6648 |
| Aluminum Wire | 12 | 1440 | 2496 | 2880 | 3324 |
| | 10 | 2400 | 4160 | 4800 | 5540 |

2. Wire entry into a draft barrier installation is commonly made into one draft barrier heater. Through wiring (factory furnished) is used for connection to adjacent heaters.
3. 1/2 & 3/4 knockouts are located at each end of the heater back panel for wire entry. a knockout is also located on each side of the junction box.
4. All wiring and electrical grounding of the heater back panel to be in accordance with national electrical code and applicable local codes. A grounding terminal in the heater splice compartment is provided for this purpose.

TO INSTALL DBTS:

1. Once installation height has been determined, proper markings along the wall should be made to insure that the heater will mounted evenly. If the wall surface is not even, attach the back panel to the high spots. This will eliminate a distorted appearance. shims can be used to maintain a straight line along the front surface if necessary. series dbts heaters must be mounted a minimum of 2" from finished floor.
2. When multiple heaters are to be wired together, remove terminal box end knockouts.
3. Mount the back panel to the wall using suitable fasteners (by installer).
4. When heater sections are mounted end to end, install a chase nipple and locknut in the terminal box end knockouts to insure grounding continuity and to protect the wiring. where heater sections are spaced apart, rigid conduit (by installer) should be used to enclose the wire and insure grounding continuity. Use rigid conduit (by installer) when wiring through corner sections to enclose wire and insure grounding continuity.

IMPORTANT INSTRUCTIONS

When using electrical appliances, basic precautions should always be followed to reduce the risk of fire, electric shock, and injury to persons, including the following:

1. Read all instructions before using this heater.
2. A heater has hot and arcing or sparking parts inside. do not use it in areas where gasoline, paint, or flammable liquids are used or stored.
3. This heater is hot when in use. to avoid burns, do not let bare skin touch hot surfaces. If provided, use handles when moving this heater. keep combustible materials, such as furniture, pilows, bedding, papers, clothes, and curtains away from heater.
4. To prevent a possible fire, do not block air intakes or exhaust in any manner. Do not use on soft surfaces, like a bed, where openings may become blocked.
5. Do not insert or allow foreign objects to enter any ventilation or exhaust opening as this may cause an electric shock or fire, or damage the heater.
6. **"SAVE THESE INSTRUCTIONS"**

NOTICE:

To ensure a proper installation, make sure that all pieces are securely snap fitted. For ease of installation, snap bottom of front cover first, and then snap top part of the front cover to the back plate. Do not operate heater unless front cover is in place.

CAUTION: HIGH TEMPERATURES

Keep electrical cords, furniture, draperies or any other blocking material away from heater. Do not install heaters against paperboard or low density fiberboard surfaces. Do not place heater below electrical convenience receptacle.

NOTICE:

When using either 1/2" or 3/4" emt for field wiring, do not exceed allowable numbers of conductors according to the national electric code.

CONTROLS: All controls are mounted in 6 or 12" control section.

DESCRIPTION: Single Pole
 CATALOG NO.: DBTS-ITS
 RATED 25 Amps at 120-277. 50-90°F temperature range.
 Tamperproof and adjustable thru discharge louver.

DESCRIPTION: Disconnect Switch
 CATALOG NO.: DBTS-IDS
 Double Pole, rated 20 Amps at 120-277V.

When heaters are furnished with controls, make certain that the heater or heaters do not exceed the lowest amperage rating of the controls furnished. For example, if a thermostat and disconnect are furnished, the thermostat is rated at 25 amps at 240 and 277. The disconnect is rated 20 amps, 240 and 277. The combination of heaters should not exceed 20 amps at 240 or 277.

DESCRIPTION: Double Pole thermostat
 CATALOG NO.: DBTS-ITD
 RATED 25 Amps at 120-277.
 Temperature Rang: 50-90°F
 Tamperproof and adjustable thru discharge louver.

- Field wiring with integral controls
- Integral thermostats: wire entry from either end. Control section.
 - Disconnect Switch: Right hand entry. Control section.
 - Relays: right hand entry-control section
 - Thermostat, disconnect and relay: Right hand entry-control section.

WIRING DIAGRAMS

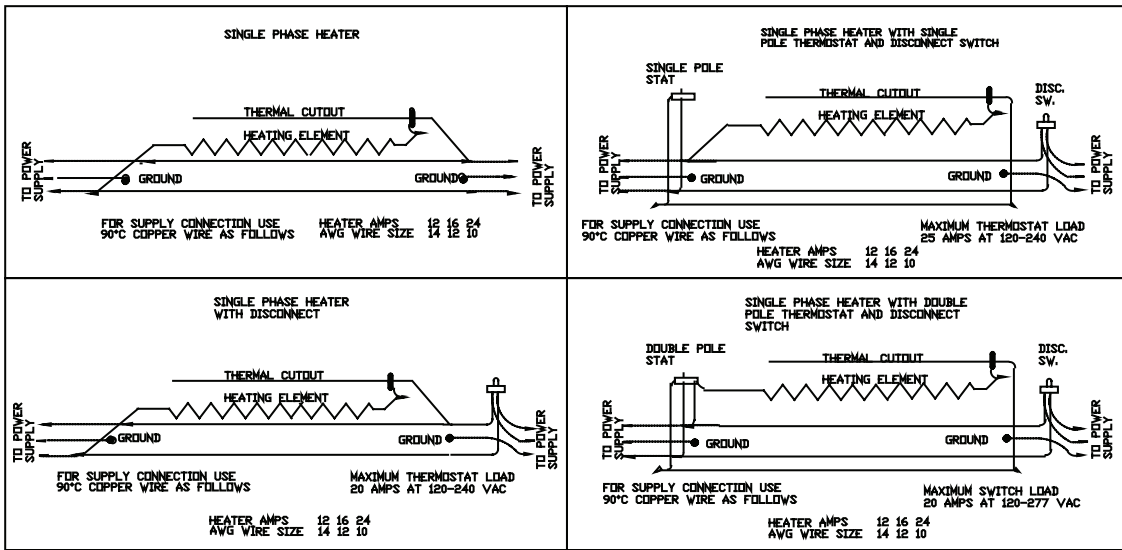

WIRING DIAGRAMS-CONTROL SECTION

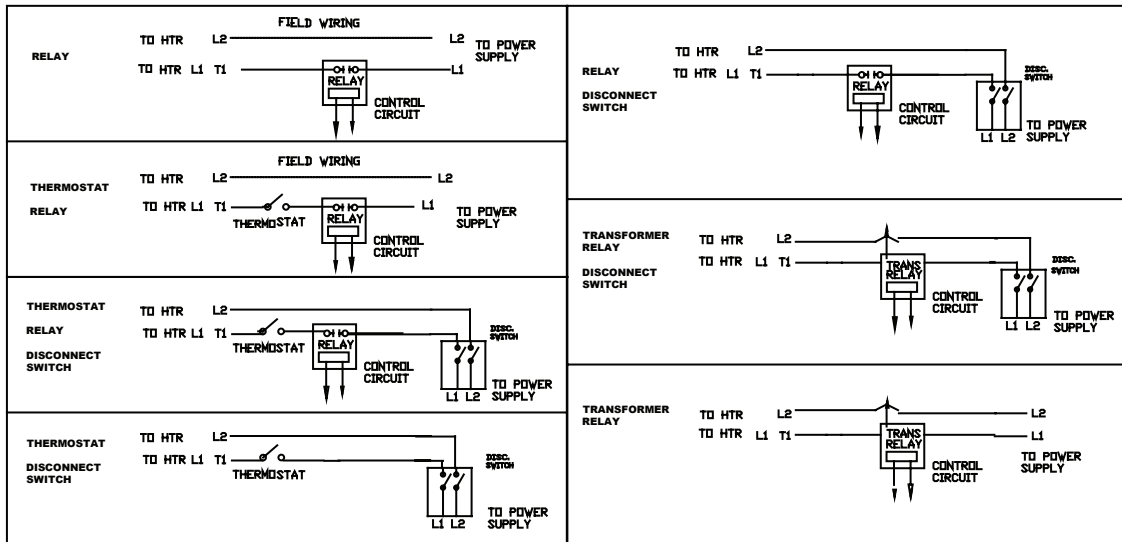

CAUTION AND WARNING STATEMENT - DBTS DRAFT BARRIER

Wiring procedures and connections should be in accordance with nation and local codes having jurisdiction. Note: all baseboard must be grounded in accordance with article 250 of N.E.C.

Do not install baseboard heater below electrical convenience receptacles (outlets).

High temperatures are present at outlet openings. Keep electrical cords, drapes and other furnishings or objects clear of these openings.

To reduce risk of fire, do not store or use gasoline or other flammable vapors and liquids in the vicinity of the heaters.

High temperatures, keep electrical cords, drapes and other furnishings away from the heater.

RECOMMENDATIONS FOR DRAPE PLACEMENT NEAR BASEBOARD HEATER

Allow minimum clearance of 1" from drapes to ceiling and top of floor covering to permit air circulation (example 1).

Hang full length drapes to provide a minimum of 2" airspace between heater front and nearest drape fold as shown in (example 1.)

Hang short drapes to provide minimum of 6" clearance between bottom of drapes and top of heater, preferably more (example 2).

Do not under any condition allow drapery to come in contact with heater. Some fabrics discolor in time from exposure to sunlight or warm air.

Check to make sure drapery material will not discolor, shrink, or stretch upon extended (1000 hour) exposure to temperatures of 200°F.

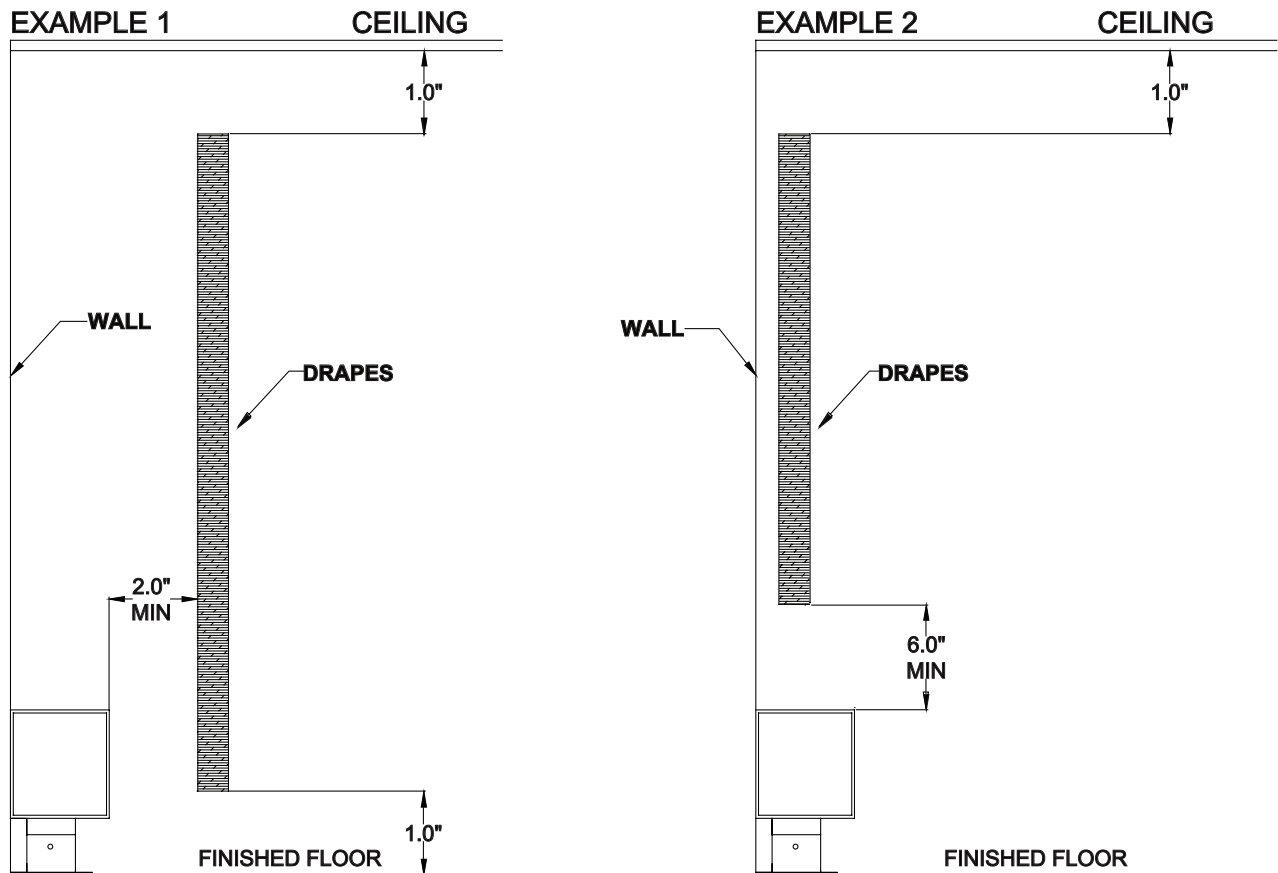

MINIMUM CLEARANCES FOR DRAPES (INCHES)

INSTALLATION

KNOCKOUTS AND MOUNTING HOLES TYPES DBTS

TYPE DBTS

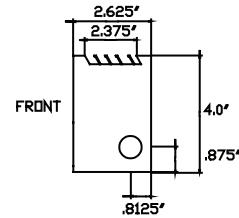
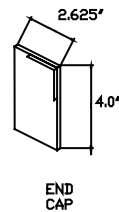
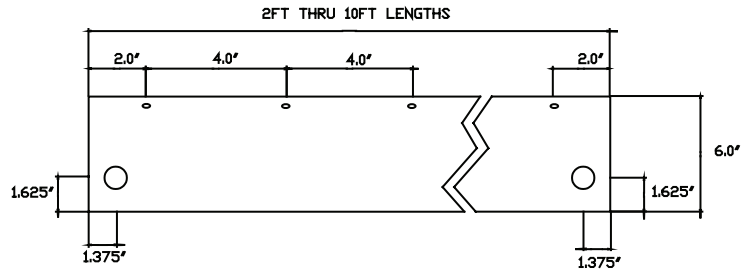
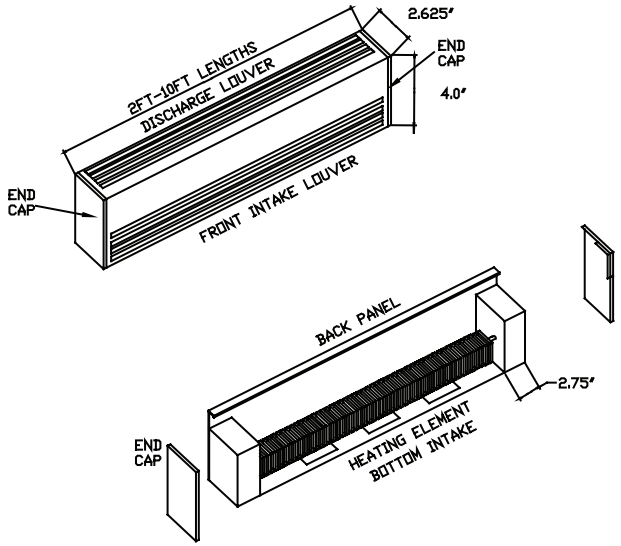

TYPICAL INSTALLATION

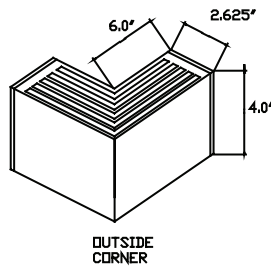
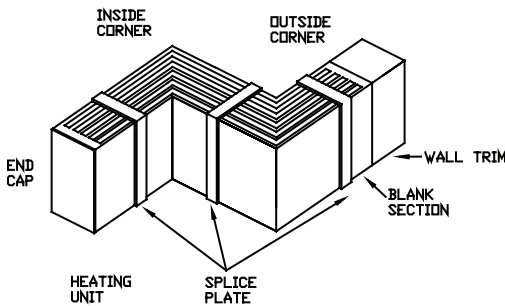

ACCESSORIES

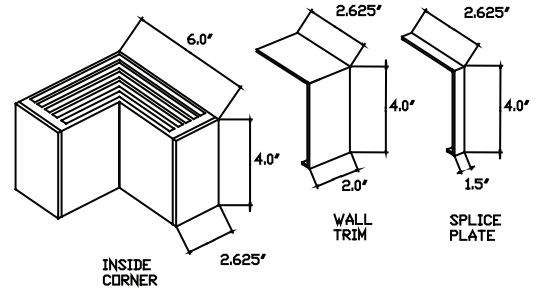

ARCHITECTURAL PEDESTAL HEATERS
SERIES DBTS-PD
DBTS 100-250 WATTS PER FOOT

